



RETAINING WALLS FOR THE INFRASTRUCTURE MARKET

Coping with height differences, terracing, driveways, enclosures, infrastructure works, parking lots, etc.







Content

4	CBS Beton: the standard for concrete systems
5	Our core values
6	Standardisation, design, production & quality control
7	Wall construction
8-9	Unique to our walls
10-11	Placement
12-13	Loads cases
14-19	L-walls CLF10GS range
20-23	L-walls DLF10GS range
24-27	Customized L-walls
28-31	Corner elements
32	Border stones
33	Convex and concave arcs
34	Parapet attachment
35	Loading and packing - lifting hooks





CBS BETON: THE REFERENCE FOR CONCRETE SYSTEMS

Spotlight on retaining walls

If you take a good look, you'll be amazed at how many applications suit our concrete elements. Together with our customers, we are completing wonderful projects in Belgium, France, the Netherlands, Luxembourg and Germany, ranging from public procurement projects to installations for industry, agriculture, landscaping, biogas, etc., all of which must meet precise quality requirements.

It is becoming increasingly apparent how **quick and easy** the use of precast concrete is: placement goes smoothly, with preparation time at a minimum. And once the elements are in place, there's no further maintenance required. Our aim is to achieve a **fair price-quality ratio** for a product that is **functional** and as **aesthetic** as it can be.

Engineers and constructors

For those who have a less mundane application or want a little extra, CBS Concrete thinks along with you: gabions, stadium terraces, an amphitheatre, printed walls (e.g. wood and stone), etc. Tell us what you're looking for. Our engineers, draughtsmen and production managers will work with you. Together with our enthusiastic sales team, they provide a top service with just that little bit more: customer-orientated thinking with attention to your budget and schedule.

Quality – Certificates – Service

Since our founding in the late 1990s, production in Wielsbeke has evolved enormously, in both quality and organisation.

We constantly work to meet the demands of the marketplace in terms of **quality** – we have our own lab where samples are taken from production every day. We also have the necessary **certificates**. And we have the enthusiasm required to continue to earn them.

Service An important word of great importance to us at CBS Concrete Even if things go differently than expected, we make every effort to bring your project to a successful conclusion.

We want to continue to grow and evolve, but that can only be done together with you. Tell us what you want to create and we'll cast your ideas into a concrete form.

And last but not least ... CBS Beton also offers a **comprehensive logistics service**, from loading your truck to organising deliveries to the job site, with or without positioning from the truck. You ask, we produce and deliver.

Our core values



We have a constant stock and an extensive range.



We have a very short production time and can switch quickly for fitting work



Continuous product improvements thanks to our own engineering and quality divisions.



CBS LOGISTICS: loading your truck, organising deliveries to the job site, with or without placement from the truck.



We have the right skills in house to handle your specific request.



High degree of finish of our concrete elements. Always a bullseye.



After reviewing your request, we'll send you a quote within the shortest possible time.



We work to find a solution when you ask for customisation.

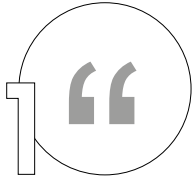

Standardisation, design, production & quality control

DID YOU KNOW ...

CBS Beton was the first manufacturer to obtain a BENOR certificate for retaining walls. This certificate confirms that our retaining walls comply with Belgian and European standards. CBS Concrete is the only manufacturer with an in-house design and engineering office. This allows us to work out an appropriate proposal to avoid surprises during execution of your project.

Retaining walls from CBS Beton are manufactured in accordance with **European concrete standard NBN EN 206** and **Belgian national supplement NBN B 15-001**, as well as the **European standard for prefabricated concrete retaining walls, NBN EN 15258**. CBS Beton also holds CE certificate EN 15258 for prefabricated retaining wall elements.

Our retaining walls are designed in accordance with the applicable standards.

- NBN EN 1990: Eurocode 0 - Basis for structural design
- NBN EN 1991: Eurocode 1 - Loads on structures (+ national annexes)
- NBN EN 1992: Eurocode 2 - Design and calculation of concrete structures
- NBN EN 1997: Eurocode 7 - Geotechnical design



Design principles

- Concrete strength class: high-strength concrete C60/75
- Environmental classes (NBN EN 206):

- XC4: alternating wet and dry
- XD3: alternating wet and dry, in contact with chlorides (de-icing salts)
- XF4: high water saturation with de-icing salts
- Others on request

- Environmental classes (NBN B 15-001):

- EE4: frost and de-icing salts
- Others on request

- The following properties are taken into account with respect to the backfill material:

- Internal friction angle: $k = 32.5^\circ$
- Weight by volume: $k = 18 \text{ kN/m}^3$

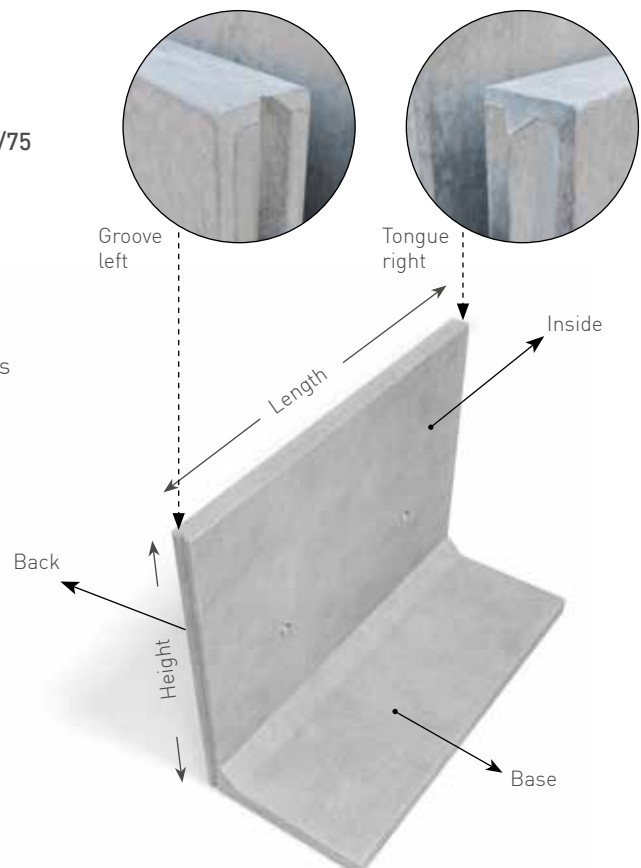



2 “

Execution of the walls

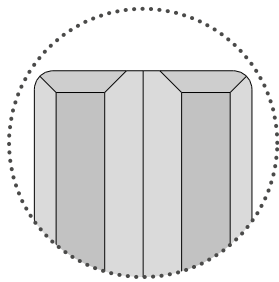

Rounded bevels
along the top of the retaining wall.

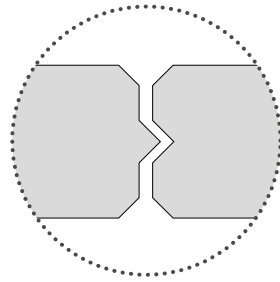

Tongue and groove connection.

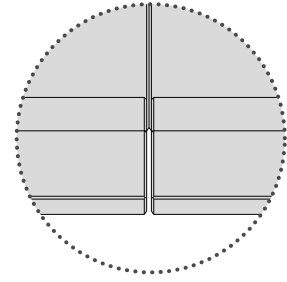

Under the base, there is a **sand gap** to make it easier to locate the walls so that the top sides fit nicely.

Special executions possible.

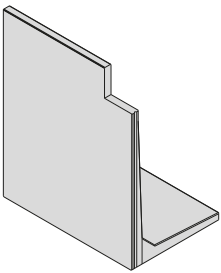

Recess

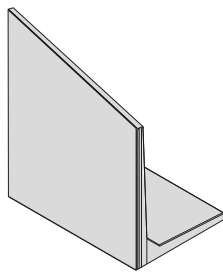

Bevel

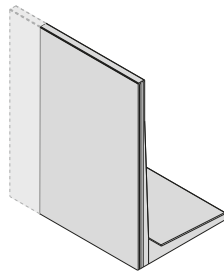

Length adjustment

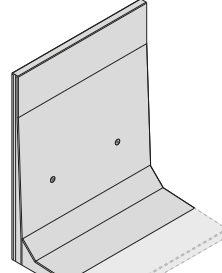

Base shortened

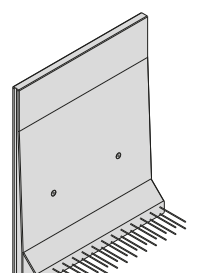

Base with excellent reinforcement



Unique to our walls

The upper part of the wall forms one line when retaining walls of different heights are installed. This way, the different walls do not stand out and you get a nice aesthetic appearance. **The green part indicates the level to which the 10 cm thickness is maintained** according to the length of each wall.

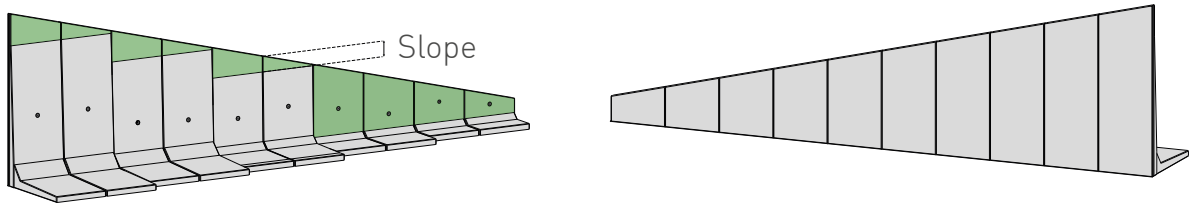

Elements of varying height on a continuous foundation and with sloping top edges.

Slope up to 50 cm over 1 metre

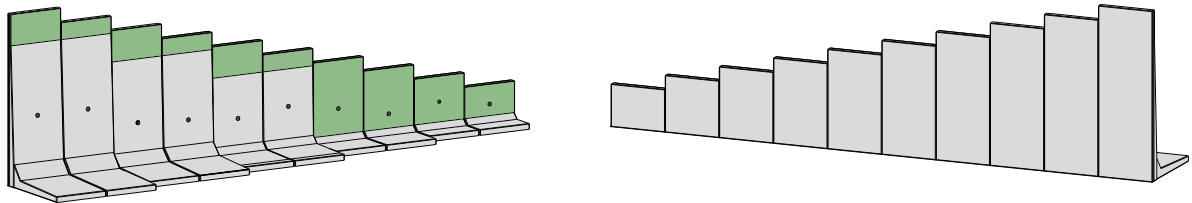

Elements of different heights on a continuous foundation

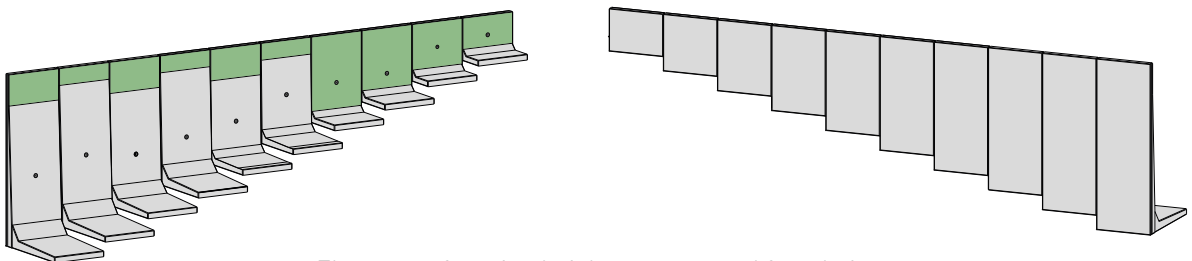

Elements of varying height on a stepped foundation

The green section has a constant wall thickness of 10 cm.

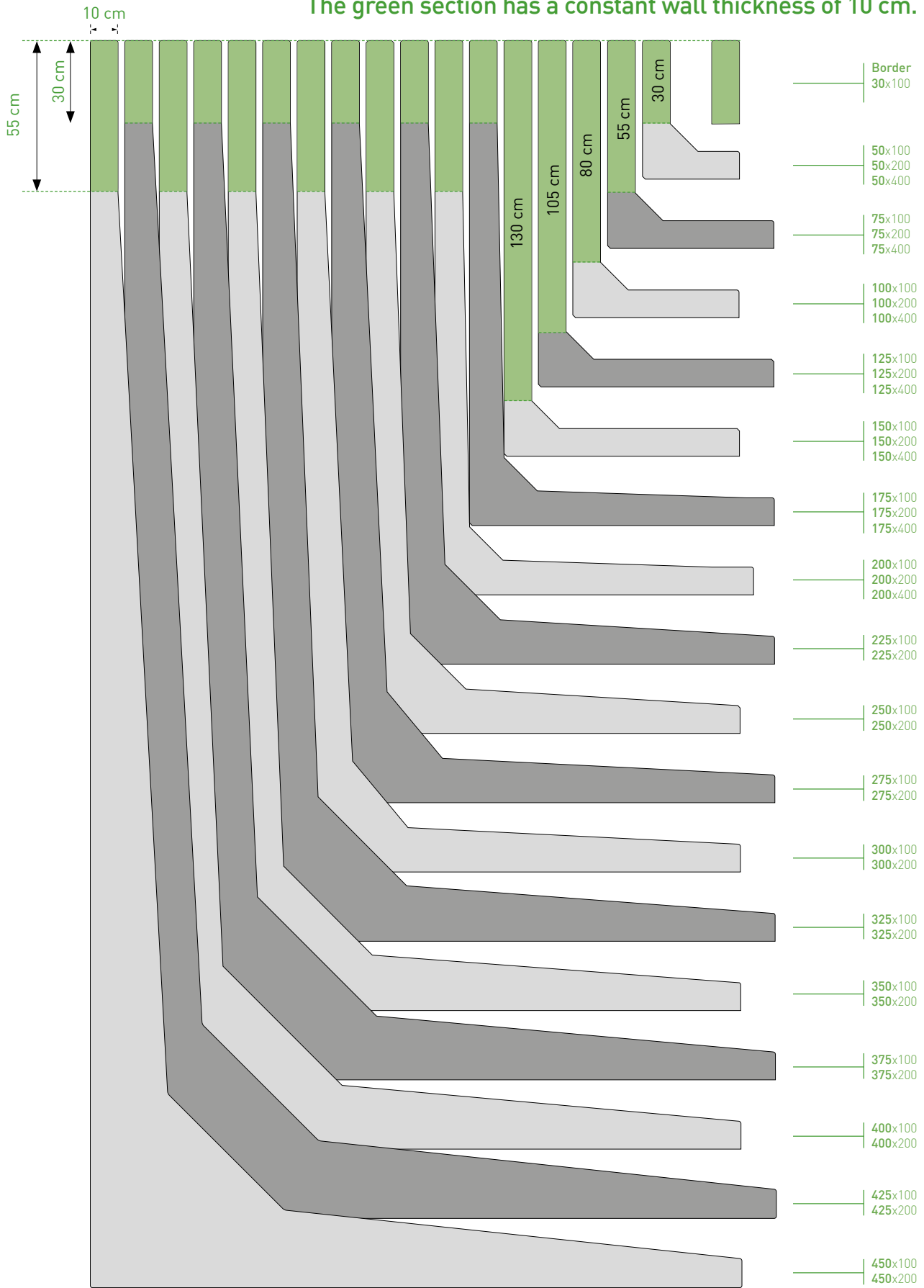

On request from a height of 6.25m

475 - 500 - 500 - 550 - 575 - 600
625 - 650 - 675 - 700



Placement

The retaining walls must be backfilled with a non-cohesive material, e.g. sand, gravel or crushed stone, **compacted in layers of 30 cm**. The compaction equipment must remain at a distance of at least **1/3 of the wall height or 50 cm from the retaining wall**.

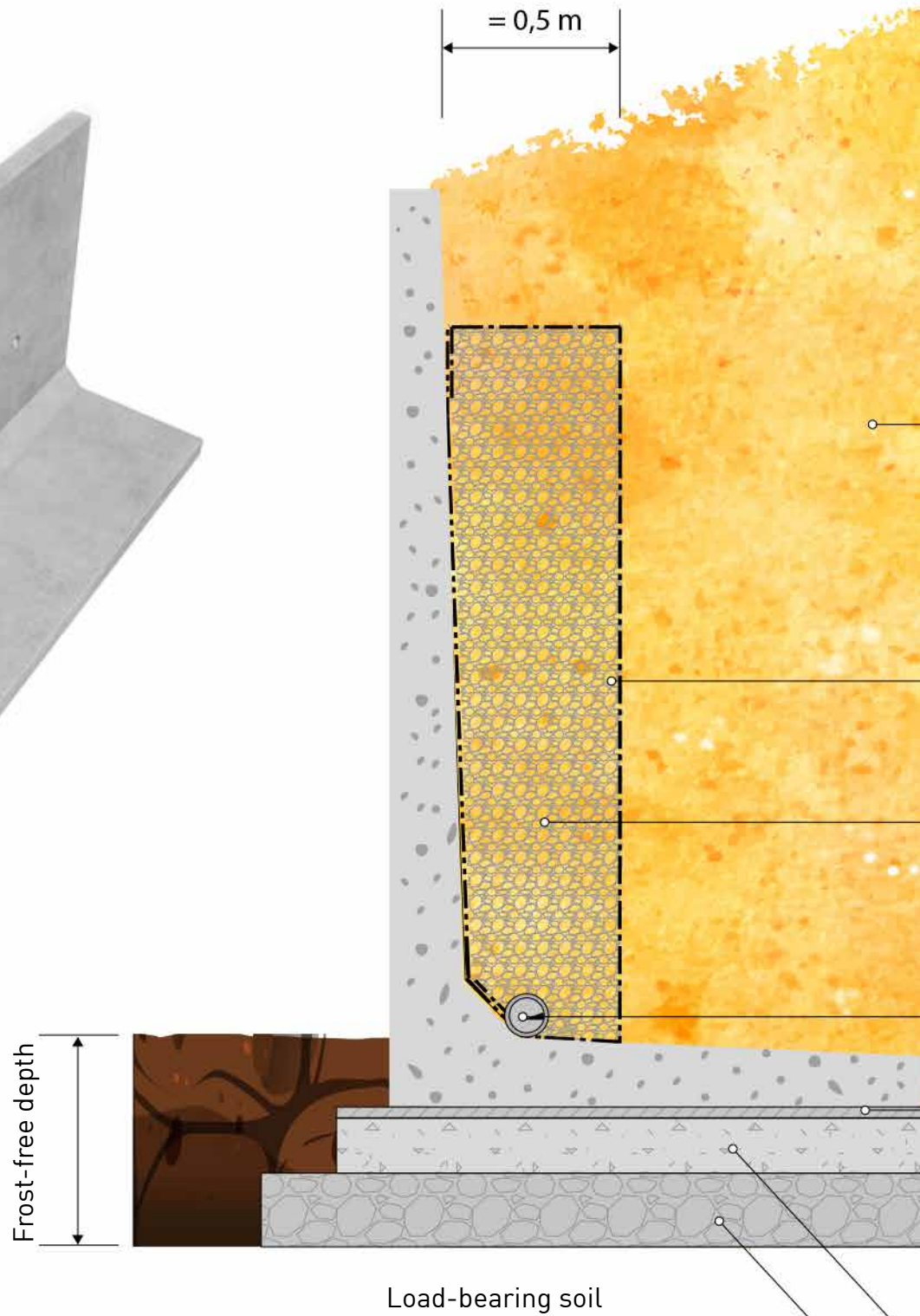
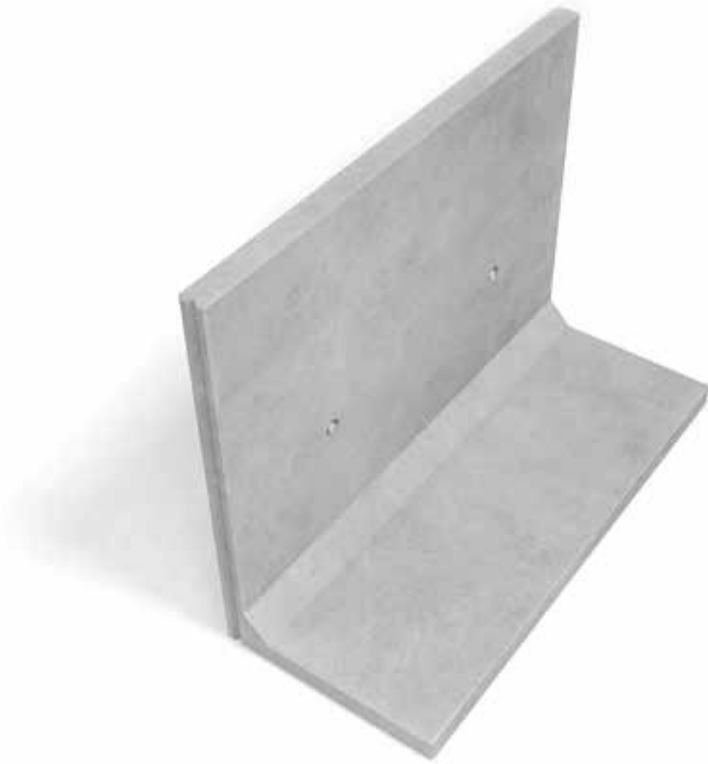

The design of the foundation is done by the contractor, based on:

- the load-bearing capacity of the substrate
- the foundation pressure, as calculated in the CBS Beton calculation note.

Sand or crushed stone, to be compacted in layers of max. 30 cm (internal friction angle 32.5°)

Geotextile

Drainage materials

Drainage pipe min. diameter 60 mm

Mortar or sand-cement foundation layer

Foundation: sand cement (150 kg cement per m³) or lean concrete (C12/15)

Sub-foundation: crushed stone (0/40)



Types of loads

3 WALL FORMULAS AND THEIR USE

We can offer you 3 formulas in the range of fully smooth-formed retaining walls, each with its specific characteristics:

- 1) CLF10GS-GAMMA for standard overload
- 2) DLF10GS-GAMMA for heavy overload
- 3) CUSTOMIZED L-WALLS

R = rear reinforcement
Z = with heel

Formula 1

CLF10GS Standard walls

CLF10GS: STANDARD OVERLOAD



CLF10GS
uniform distributed overload
10 kN/m²
light traffic max. 3.5 tons

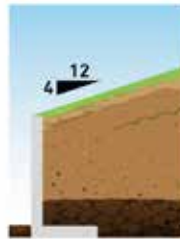

CLF10GS
slope 12:4

CLF10GSZ: STANDARD OVERLOAD Use with lower bearing capacity



CLF10GSZ
uniform distributed overload
10 kN/m²
light traffic max. 3.5 tons

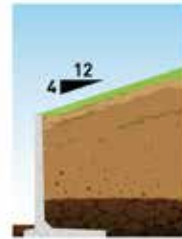

CLF10GSZ
slope 12:4

CLF10GSR: REVERSE PLACEMENT



CLF10GSR
uniform distributed overload
5 kN/m² no traffic,
just pedestrians/cyclists

CLF10GSRZ: REVERSE PLACEMENT



CLF10GSRZ
uniform distributed overload
10 kN/m²
light traffic max. 3.5 tons

Formula 2

DLF10GS

Walls for heavy overload

DLF10GS: HEAVY OVERLOAD



DLF10GS
uniform distributed
overload 25 kN/m²

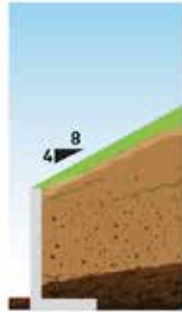

DLF10GS
slope 8:4



DLF10GS
uniformly distributed
overload 40 kN/m² at edge
distance 1 m equivalent to
load mode LM1 according to
NBN EN 1991-2

DLF10GSZ:

HEAVY OVERLOAD

Use with lower bearing capacity substrate



DLF10GSZ
uniform distributed
overload 25 kN/m²



DLF10GSZ
slope 8:4



DLF10GSZ
uniformly distributed
overload 40 kN/m² at edge
distance 1 m equivalent to
load mode LM1 according to
NBN EN 1991-2

DLF10GSRZ:

REVERSE PLACEMENT



DLF10GSRZ
uniform distributed
overload 25 kN/m²

Formula 3

CUSTOMIZED L-WALLS

Variable walls for standard, heavier and demanding loads.

LVF-WALLS

FOR STANDARD, AND HEAVIER OVERLOADS

Variable walls 12-15 and 20 cm



LVF RANGE
heavy traffic, uniform distributed
overload according to NBN EN 1991-2

ELF-WALLS

HEAVY OVERLOAD

Specific conditions



ELF RANGE
heavy traffic according to
NBN EN 1991-2 edge
distance 0 m



ELF RANGE
heavy traffic according to
NBN EN 1991-2



ELF RANGE
heavy traffic according to NBN EN
1991-2

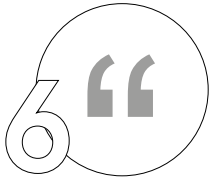

L-walls CLF10GS range

Formula 1

CLF10GS Standard retaining wall

Top thickness	Always 10 cm
Standard lengths	1 m - 2 m - 4 m
Connection	Tongue and groove
Top finish	Rounded bevels
Finish	Smooth
Special features	Sand gap
Concrete quality	C 60/75



CLF10GS

STANDARD L-WALLS

Standard load base side

Corner elements, page 28

CLF10GS:
STANDARD OVERLOAD



CLF10GS
uniform distributed overload
10 kN/m²
light traffic max. 3.5 tons

CLF10GS
slope 12:4

		HEIGHT CM	LENGTH CM	BASE CM	TOP THICK- NESS CM	WEIGHT KG	KKA	CONNECTION	CONCRETE QUALITY	MAX. NUMBER OF PIECES PER PALETTE
LONGUEUR 1 M	CLF10GS50x100	50	100	35	10	195	1 x 2,5 T	tongue and groove	C60/75	4
	CLF10GS75x100	75	100	60	10	310	1 x 2,5 T	tongue and groove	C60/75	5
	CLF10GS100x100	100	100	60	10	370	1 x 2,5 T	tongue and groove	C60/75	5
	CLF10GS125x100	125	100	85	10	495	1 x 2,5 T	tongue and groove	C60/75	3
	CLF10GS150x100	150	100	85	10	555	1 x 2,5 T	tongue and groove	C60/75	3
	CLF10GS175x100	175	100	115	10	770	1 x 2,5 T	tongue and groove	C60/75	3
	CLF10GS200x100	200	100	115	10	830	1 x 2,5 T	tongue and groove	C60/75	3
	CLF10GS225x100	225	100	135	10	1150	2 x 2,5 T	tongue and groove	C60/75	0
	CLF10GS250x100	250	100	135	10	1210	2 x 2,5 T	tongue and groove	C60/75	0
	CLF10GS275x100	275	100	160	10	1520	2 x 5 T	tongue and groove	C60/75	0
	CLF10GS300x100	300	100	160	10	1580	2 x 5 T	tongue and groove	C60/75	0
	CLF10GS325x100	325	100	185	10	1965	2 x 5 T	tongue and groove	C60/75	0
	CLF10GS350x100	350	100	185	10	2025	2 x 5 T	tongue and groove	C60/75	0
	CLF10GS375x100	375	100	210	10	2590	4 x 5 T	tongue and groove	C60/75	0
	CLF10GS400x100	400	100	210	10	2650	4 x 5 T	tongue and groove	C60/75	0
	CLF10GS425x100	425	100	235	10	3290	4 x 10 T	tongue and groove	C60/75	0
	CLF10GS450x100	450	100	235	10	3355	4 x 10 T	tongue and groove	C60/75	0
CLF10GS500x100	500	100	260	13	5245	4 x 10 T	tongue and groove	C60/75	0	
CLF10GS550x100	550	100	260	10	5434	4 x 10 T	tongue and groove	C60/75	0	
CLF10GS600x100	600	100	260	10	5853	4 x 10 T	tongue and groove	C60/75	0	

* From the height 5m = KKA + RTA 10T

LONGUEUR 2 M	CLF10GS50x200	50	200	35	10	385	2 x 2,5 T	tongue and groove	C60/75	4
	CLF10GS75x200	75	200	60	10	625	2 x 2,5 T	tongue and groove	C60/75	4
	CLF10GS100x200	100	200	60	10	745	2 x 2,5 T	tongue and groove	C60/75	4
	CLF10GS125x200	125	200	85	10	995	2 x 2,5 T	tongue and groove	C60/75	3
	CLF10GS150x200	150	200	85	10	1115	2 x 2,5 T	tongue and groove	C60/75	3
	CLF10GS175x200	175	200	115	10	1545	2 x 2,5 T	tongue and groove	C60/75	0
	CLF10GS200x200	200	200	115	10	1665	2 x 2,5 T	tongue and groove	C60/75	0
	CLF10GS225x200	225	200	135	10	2300	2 x 2,5 T	tongue and groove	C60/75	0
	CLF10GS250x200	250	200	135	10	2425	2 x 2,5 T	tongue and groove	C60/75	0
	CLF10GS275x200	275	200	160	10	3050	2 x 5 T	tongue and groove	C60/75	0
	CLF10GS300x200	300	200	160	10	3175	2 x 5 T	tongue and groove	C60/75	0
	CLF10GS325x200	325	200	185	10	3940	2 x 5 T	tongue and groove	C60/75	0
	CLF10GS350x200	350	200	185	10	4060	2 x 5 T	tongue and groove	C60/75	0
	CLF10GS375x200	375	200	210	10	5190	4 x 5 T	tongue and groove	C60/75	0
	CLF10GS400x200	400	200	210	10	5310	4 x 5 T	tongue and groove	C60/75	0
	CLF10GS425x200	425	200	235	10	6605	4 x 10 T	tongue and groove	C60/75	0
	CLF10GS450x200	450	200	235	10	6725	4 x 10 T	tongue and groove	C60/75	0
CLF10GS500x200	500	200	260	13	10566	4 x 10 T	tongue and groove	C60/75	0	
CLF10GS550x200	550	200	260	10	10902	4 x 10 T	tongue and groove	C60/75	0	
CLF10GS600x200	600	200	260	10	11261	4 x 10 T	tongue and groove	C60/75	0	

* From the height 5m = KKA + RTA 10T

LONGUEUR 4 M	CLF10GS50x400	50	400	35	10	770	2 x 2,5 T	tongue and groove	C60/75	4 x 2 pal
	CLF10GS75x400	75	400	60	10	1250	2 x 2,5 T	tongue and groove	C60/75	4 x 2 pal
	CLF10GS100x400	100	400	60	10	1490	2 x 2,5 T	tongue and groove	C60/75	4 x 2 pal
	CLF10GS125x400	125	400	85	10	1990	2 x 2,5 T	tongue and groove	C60/75	2 x 2 pal
	CLF10GS150x400	150	400	85	10	2235	2 x 2,5 T	tongue and groove	C60/75	0
	CLF10GS175x400	175	400	115	10	3090	2 x 2,5 T	tongue and groove	C60/75	0
	CLF10GS200x400	200	400	115	10	3330	2 x 2,5 T	tongue and groove	C60/75	0

	Constant wall thickness of 10 cm
	Wall thickness of 10 cm at top

CAUTION, DLF10GSZ500x100 and the DLF10GSZ500x200 have a top thickness of 13 cm.

CLF10GSR

L-WALLS FOR REVERSE PLACEMENT

With these walls, the rear side is under load.
The base must be back-filled to 1/3 of its height.



CLF10GSR
uniform distributed overload
5 kN/m² no traffic,
just pedestrians/cyclists

		HEIGHT CM	LENGTH CM	BASE CM	TOP THICK- NESS CM	WEIGHT KG	KKA	CONNECTION	CONCRETE QUALITY	MAX. NUMBER OF PIECES PER PALETTE
LENGTH 1 M	CLF10GSR125x100	125	100	85	10	500	1 x 2,5 T	tongue and groove	C60/75	3
	CLF10GSR150x100	150	100	85	10	565	1 x 2,5 T	tongue and groove	C60/75	3
	CLF10GSR175x100	175	100	115	10	780	1 x 2,5 T	tongue and groove	C60/75	3
	CLF10GSR200x100	200	100	115	10	840	1 x 2,5 T	tongue and groove	C60/75	3
	CLF10GSR225x100	225	100	135	10	1160	2 x 2,5 T	tongue and groove	C60/75	0
	CLF10GSR250x100	250	100	135	10	1225	2 x 2,5 T	tongue and groove	C60/75	0
	CLF10GSR275x100	275	100	160	10	1540	2 x 5 T	tongue and groove	C60/75	0
	CLF10GSR300x100	300	100	160	10	1600	2 x 5 T	tongue and groove	C60/75	0
	CLF10GSR325x100	325	100	185	10	1990	2 x 5 T	tongue and groove	C60/75	0
	CLF10GSR350x100	350	100	185	10	2050	2 x 5 T	tongue and groove	C60/75	0
	CLF10GSR375x100	375	100	210	10	2620	4 x 5 T	tongue and groove	C60/75	0
	CLF10GSR400x100	400	100	210	10	2680	4 x 5 T	tongue and groove	C60/75	0
	CLF10GSR425x100	425	100	235	10	3335	4 x 10 T	tongue and groove	C60/75	0
CLF10GSR450x100	450	100	235	10	3395	4 x 10 T	tongue and groove	C60/75	0	
LENGTH 2 M	CLF10GSR125x200	125	200	85	10	1005	2 x 2,5 T	tongue and groove	C60/75	3
	CLF10GSR150x200	150	200	85	10	1130	2 x 2,5 T	tongue and groove	C60/75	3
	CLF10GSR175x200	175	200	115	10	1560	2 x 2,5 T	tongue and groove	C60/75	0
	CLF10GSR200x200	200	200	115	10	1685	2 x 2,5 T	tongue and groove	C60/75	0
	CLF10GSR225x200	225	200	135	10	2330	2 x 2,5 T	tongue and groove	C60/75	0
	CLF10GSR250x200	250	200	135	10	2455	2 x 2,5 T	tongue and groove	C60/75	0
	CLF10GSR275x200	275	200	160	10	3090	2 x 5 T	tongue and groove	C60/75	0
	CLF10GSR300x200	300	200	160	10	3210	2 x 5 T	tongue and groove	C60/75	0
	CLF10GSR325x200	325	200	185	10	3990	2 x 5 T	tongue and groove	C60/75	0
	CLF10GSR350x200	350	200	185	10	4110	2 x 5 T	tongue and groove	C60/75	0
	CLF10GSR375x200	375	200	210	10	5255	4 x 5 T	tongue and groove	C60/75	0
	CLF10GSR400x200	400	200	210	10	5375	4 x 5 T	tongue and groove	C60/75	0
	CLF10GSR425x200	425	200	235	10	6685	4 x 10 T	tongue and groove	C60/75	0
CLF10GSR450x200	450	200	235	10	6810	4 x 10 T	tongue and groove	C60/75	0	
4 M	CLF10GSR125x400	125	400	85	10	2015	2 x 2,5 T	tongue and groove	C60/75	0
	CLF10GSR150x400	150	400	85	10	2260	2 x 2,5 T	tongue and groove	C60/75	0
	CLF10GSR175x400	175	400	115	10	3125	2 x 2,5 T	tongue and groove	C60/75	0
	CLF10GSR200x400	200	400	115	10	3375	2 x 2,5 T	tongue and groove	C60/75	0

- Constant wall thickness of 10 cm
- Wall thickness of 10 cm at top

H 50 -75 -100: CLF10GS is sufficient for reverse placement.

CLF10GSZ

L-WALLS FOR STANDARD USE, WITH HEEL

A heel is used when the bearing capacity of the substrate is lower.

CLF10GSZ:
STANDARD OVERLOAD
Use with lower bearing capacity



CLF10GSZ
uniform distributed overload
10 kN/m²
light traffic max. 3.5 tons

CLF10GSZ
slope 12:4

	HEIGHT CM	LENGTH CM	BASE CM	TOP THICK- NESS CM	WEIGHT KG	KKA	CONNECTION	CONCRETE QUALITY	
LENGTH 1 M	CLF10GSZ50x100	50	100	65	10	265	3 x 2,5 T	tongue and groove	C60/75
	CLF10GSZ75x100	75	100	90	10	385	3 x 2,5 T	tongue and groove	C60/75
	CLF10GSZ100x100	100	100	90	10	450	3 x 2,5 T	tongue and groove	C60/75
	CLF10GSZ125x100	125	100	115	10	574	1 x 2,5 T	tongue and groove	C60/75
	CLF10GSZ150x100	150	100	115	10	625	1 x 2,5 T	tongue and groove	C60/75
	CLF10GSZ175x100	175	100	145	10	850	1 x 2,5 T	tongue and groove	C60/75
	CLF10GSZ200x100	200	100	145	10	910	1 x 2,5 T	tongue and groove	C60/75
	CLF10GSZ225x100	225	100	165	10	1240	2 x 2,5 T	tongue and groove	C60/75
	CLF10GSZ250x100	250	100	165	10	1305	2 x 2,5 T	tongue and groove	C60/75
	CLF10GSZ275x100	275	100	200	10	1650	2 x 5 T	tongue and groove	C60/75
	CLF10GSZ300x100	300	100	200	10	1710	2 x 5 T	tongue and groove	C60/75
	CLF10GSZ325x100	325	100	225	10	2110	2 x 5 T	tongue and groove	C60/75
	CLF10GSZ350x100	350	100	225	10	2170	2 x 5 T	tongue and groove	C60/75
	CLF10GSZ375x100	375	100	250	10	2750	4 x 5 T	tongue and groove	C60/75
	CLF10GSZ400x100	400	100	250	10	2810	4 x 5 T	tongue and groove	C60/75
CLF10GSZ425x100	425	100	285	10	3525	4 x 10 T	tongue and groove	C60/75	
CLF10GSZ450x100	450	100	285	10	3585	4 x 10 T	tongue and groove	C60/75	
LENGTH 2 M	CLF10GSZ50x200	50	200	65	10	535	4 x 2,5 T	tongue and groove	C60/75
	CLF10GSZ75x200	75	200	90	10	780	4 x 2,5 T	tongue and groove	C60/75
	CLF10GSZ100x200	100	200	90	10	900	4 x 2,5 T	tongue and groove	C60/75
	CLF10GSZ125x200	125	200	115	10	1153	2 x 2,5 T	tongue and groove	C60/75
	CLF10GSZ150x200	150	200	115	10	1275	2 x 2,5 T	tongue and groove	C60/75
	CLF10GSZ175x200	175	200	145	10	1705	1 x 2,5 T	tongue and groove	C60/75
	CLF10GSZ200x200	200	200	145	10	1830	2 x 2,5 T	tongue and groove	C60/75
	CLF10GSZ225x200	225	200	165	10	2490	2 x 2,5 T	tongue and groove	C60/75
	CLF10GSZ250x200	250	200	165	10	2615	2 x 2,5 T	tongue and groove	C60/75
	CLF10GSZ275x200	275	200	200	10	3305	2 x 5 T	tongue and groove	C60/75
	CLF10GSZ300x200	300	200	200	10	3425	2 x 5 T	tongue and groove	C60/75
	CLF10GSZ325x200	325	200	225	10	4230	2 x 5 T	tongue and groove	C60/75
	CLF10GSZ350x200	350	200	225	10	4355	2 x 5 T	tongue and groove	C60/75
	CLF10GSZ375x200	375	200	250	10	5510	4 x 5 T	tongue and groove	C60/75
	CLF10GSZ400x200	400	200	250	10	5630	4 x 5 T	tongue and groove	C60/75
	CLF10GSZ425x200	425	200	285	10	7065	4 x 10 T	tongue and groove	C60/75
	CLF10GSZ450x200	450	200	285	10	7185	4 x 10 T	tongue and groove	C60/75
CLF10GSZ500x200	500	200	325	10	11504	4 x 10 T	tongue and groove	C60/75	
CLF10GSZ550x200	550	200	325	10	11860	4 x 10 T	tongue and groove	C60/75	
CLF10GSZ600x200	600	200	325	10	12148	4 x 10 T	tongue and groove	C60/75	
LENGTH 4 M	CLF10GSZ50x400	50	400	65	10	1075	4 x 2,5 T	tongue and groove	C60/75
	CLF10GSZ75x400	75	400	90	10	1560	4 x 2,5 T	tongue and groove	C60/75
	CLF10GSZ100x400	100	400	90	10	1805	4 x 2,5 T	tongue and groove	C60/75
	CLF10GSZ125x400	125	400	115	10	2310	2 x 2,5 T	tongue and groove	C60/75
	CLF10GSZ150x400	150	400	115	10	2556	2 x 2,5 T	tongue and groove	C60/75

CLF10GSRZ

L-WALLS FOR REVERSE PLACEMENT, WITH HEEL

With these walls, the rear side is under load. The base must be back-filled to 1/4 of the height of the retaining wall.



CLF10GSRZ
uniform distributed overload
10 kN/m²
light traffic max. 3.5 tons

		HEIGHT CM	LENGTH CM	BASE CM	TOP THICK- NESS CM	WEIGHT KG	KKA	CONNECTION	CONCRETE QUALITY
LENGTH 1 M	CLF10GSRZ125x100	125	100	115	10	579	1 x 2,5 T	tongue and groove	C60/75
	CLF10GSRZ150x100	150	100	115	10	640	1 x 2,5 T	tongue and groove	C60/75
	CLF10GSRZ175x100	175	100	145	10	860	2 x 2,5 T	tongue and groove	C60/75
	CLF10GSRZ200x100	200	100	145	10	925	2 x 2,5 T	tongue and groove	C60/75
	CLF10GSRZ225x100	225	100	165	10	1260	2 x 2,5 T	tongue and groove	C60/75
	CLF10GSRZ250x100	250	100	165	10	1320	2 x 2,5 T	tongue and groove	C60/75
	CLF10GSRZ275x100	275	100	200	10	1670	2 x 5 T	tongue and groove	C60/75
	CLF10GSRZ300x100	300	100	200	10	1730	2 x 5 T	tongue and groove	C60/75
	CLF10GSRZ325x100	325	100	225	10	2135	2 x 5 T	tongue and groove	C60/75
	CLF10GSRZ350x100	350	100	225	10	2195	2 x 5 T	tongue and groove	C60/75
	CLF10GSRZ375x100	375	100	250	10	2780	4 x 5 T	tongue and groove	C60/75
	CLF10GSRZ400x100	400	100	250	10	2845	4 x 5 T	tongue and groove	C60/75
	CLF10GSRZ425x100	425	100	285	10	3565	4 x 10 T	tongue and groove	C60/75
	CLF10GSRZ450x100	450	100	285	10	3630	4 x 10 T	tongue and groove	C60/75
LENGTH 2 M	CLF10GSRZ125x200	125	200	115	10	1163	2 x 2,5 T	tongue and groove	C60/75
	CLF10GSRZ150x200	150	200	115	10	1286	2 x 2,5 T	tongue and groove	C60/75
	CLF10GSRZ175x200	175	200	145	10	1725	2 x 2,5 T	tongue and groove	C60/75
	CLF10GSRZ200x200	200	200	145	10	1850	2 x 2,5 T	tongue and groove	C60/75
	CLF10GSRZ225x200	225	200	165	10	2520	2 x 2,5 T	tongue and groove	C60/75
	CLF10GSRZ250x200	250	200	165	10	2645	2 x 2,5 T	tongue and groove	C60/75
	CLF10GSRZ275x200	275	200	200	10	3345	2 x 5 T	tongue and groove	C60/75
	CLF10GSRZ300x200	300	200	200	10	3465	2 x 5 T	tongue and groove	C60/75
	CLF10GSRZ325x200	325	200	225	10	4285	2 x 5 T	tongue and groove	C60/75
	CLF10GSRZ350x200	350	200	225	10	4405	2 x 5 T	tongue and groove	C60/75
	CLF10GSRZ375x200	375	200	250	10	5580	4 x 5 T	tongue and groove	C60/75
	CLF10GSRZ400x200	400	200	250	10	5700	4 x 5 T	tongue and groove	C60/75
	CLF10GSRZ425x200	425	200	285	10	7150	4 x 10 T	tongue and groove	C60/75
	CLF10GSRZ450x200	450	200	285	10	7275	4 x 10 T	tongue and groove	C60/75
4 M	CLF10GSRZ125x400	125	400	115	10	2329	2 x 2,5 T	tongue and groove	C60/75
	CLF10GSRZ150x400	150	400	115	10	2578	2 x 2,5 T	tongue and groove	C60/75

- Constant wall thickness of 10 cm
- Wall thickness of 10 cm at top

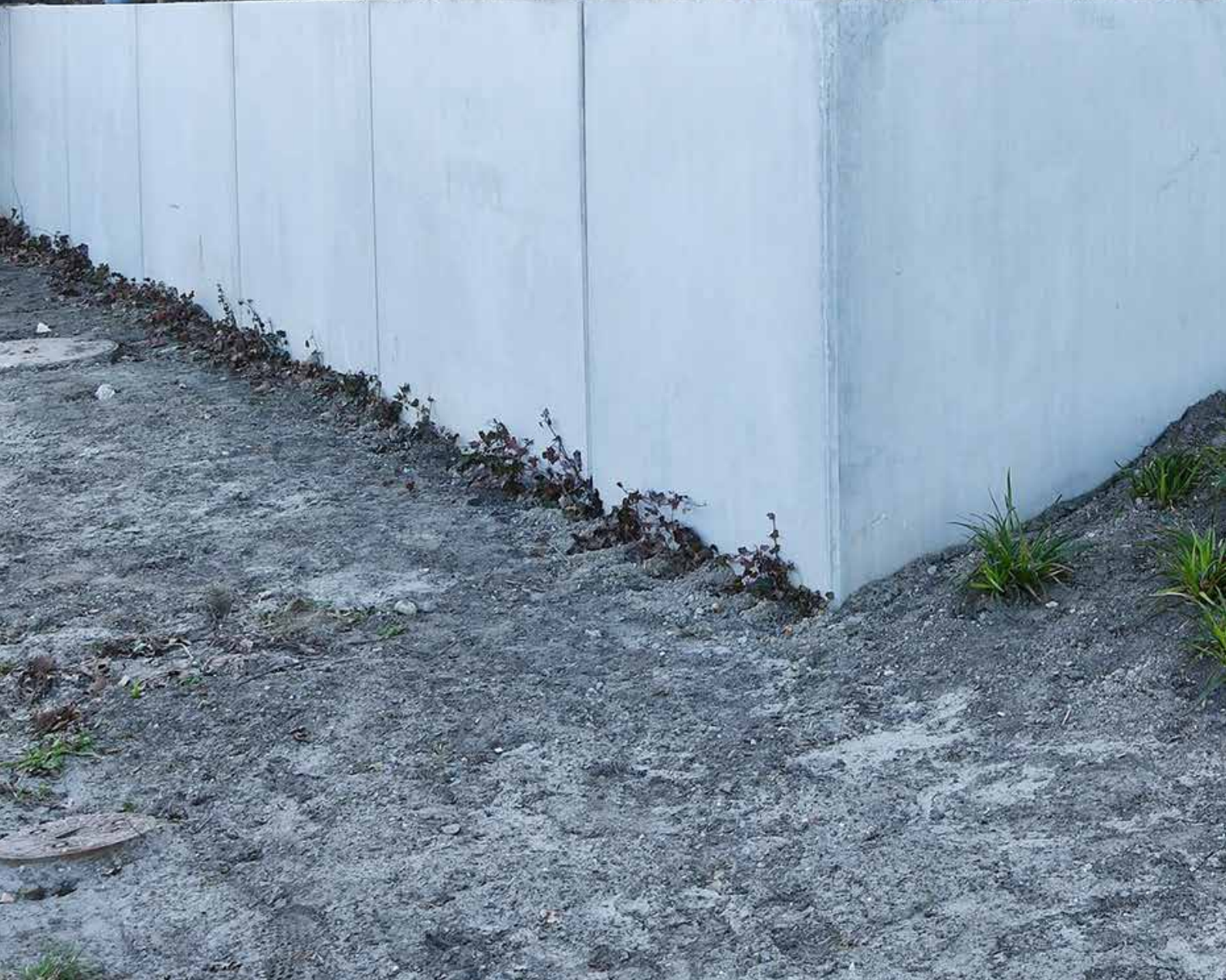

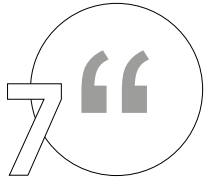

L-walls DLF10GS range

THESE ARE L-WALLS FOR HEAVIER LOADS.

Formula 2

DLF10GS for heavy overload

Top thickness	Always 10 cm
Standard lengths	1 m - 2 m - 4 m
Connection	Tongue and groove
Top finish	Rounded bevels
Finish	Smooth
Special features	Sand gap
Concrete quality	C 60/75



DLF10GS

WALLS FOR HEAVY OVERLOAD

DLF10GS: HEAVY OVERLOAD



DLF10GS
uniform distributed
overload 25 kN/m²

DLF10GS
slope 8:4

DLF10GS
uniformly distributed
overload 40 kN/m² at edge
distance 1 m equivalent to
load mode LM1 according to
NBN EN 1991-2

		HEIGHT CM	LENGTH CM	BASE CM	TOP THICK- NESS CM	WEIGHT KG	KKA	CONNECTION	CONCRETE QUALITY	MAX. NUMBER OF PIECES PER PALETTE
LENGTH 1 M	DLF10GS175x100	175	100	115	10	780	2 x 2,5 T	tongue and groove	C60/75	3
	DLF10GS200x100	200	100	115	10	840	2 x 2,5 T	tongue and groove	C60/75	3
	DLF10GS225x100	225	100	135	10	1160	2 x 2,5 T	tongue and groove	C60/75	0
	DLF10GS250x100	250	100	135	10	1225	2 x 2,5 T	tongue and groove	C60/75	0
	DLF10GS275x100	275	100	160	10	1540	2 x 5 T	tongue and groove	C60/75	0
	DLF10GS300x100	300	100	160	10	1600	2 x 5 T	tongue and groove	C60/75	0
	DLF10GS325x100	325	100	185	10	1990	2 x 5 T	tongue and groove	C60/75	0
	DLF10GS350x100	350	100	185	10	2050	2 x 5 T	tongue and groove	C60/75	0
	DLF10GS375x100	375	100	210	10	2620	4 x 5 T	tongue and groove	C60/75	0
	DLF10GS400x100	400	100	210	10	2680	4 x 5 T	tongue and groove	C60/75	0
	DLF10GS425x100	425	100	235	10	3335	4 x 10 T	tongue and groove	C60/75	0
	DLF10GS450x100	450	100	235	10	3395	4 x 10 T	tongue and groove	C60/75	0
LENGTH 2 M	DLF10GS175x200	175	200	115	10	1560	2 x 2,5 T	tongue and groove	C60/75	0
	DLF10GS200x200	200	200	115	10	1685	2 x 2,5 T	tongue and groove	C60/75	0
	DLF10GS225x200	225	200	135	10	2330	2 x 2,5 T	tongue and groove	C60/75	0
	DLF10GS250x200	250	200	135	10	2455	2 x 2,5 T	tongue and groove	C60/75	0
	DLF10GS275x200	275	200	160	10	3090	2 x 5 T	tongue and groove	C60/75	0
	DLF10GS300x200	300	200	160	10	3210	2 x 5 T	tongue and groove	C60/75	0
	DLF10GS325x200	325	200	185	10	3990	2 x 5 T	tongue and groove	C60/75	0
	DLF10GS350x200	350	200	185	10	4110	2 x 5 T	tongue and groove	C60/75	0
	DLF10GS375x200	375	200	210	10	5255	4 x 5 T	tongue and groove	C60/75	0
	DLF10GS400x200	400	200	210	10	5375	4 x 5 T	tongue and groove	C60/75	0
	DLF10GS425x200	425	200	235	10	6685	4 x 10 T	tongue and groove	C60/75	0
	DLF10GS450x200	450	200	235	10	6810	4 x 10 T	tongue and groove	C60/75	0
4 M	DLF10GSE175x400	175	400	115	10	3125	2 x 2,5 T	tongue and groove	C60/75	0
	DLF10GSE200x400	200	400	115	10	3375	2 x 2,5 T	tongue and groove	C60/75	0

Wall thickness of 10 cm at top

DLF10GSZ

WALLS FOR HEAVY OVERLOAD, WITH HEEL

This type of wall is used when the bearing capacity of the substrate is lower.

DLF10GSZ:
HEAVY OVERLOAD
Use with lower bearing capacity substrate



DLF10GSZ
uniform distributed
overload 25 kN/m²

DLF10GSZ
slope 8:4

DLF10GSZ
uniformly distributed
overload 40 kN/m² at edge
distance 1 m equivalent to
load mode LM1 according to
NBN EN 1991-2

		HEIGHT CM	LENGTH CM	BASE CM	TOP THICK- NESS CM	WEIGHT KG	KKA	CONNECTION	CONCRETE QUALITY
LENGTH 1 M	DLF10GSZ150x100	150	100	115	10	638	1 x 2,5 T	tongue and groove	C60/75
	DLF10GSZ175x100	175	100	145	10	860	1 x 2,5 T	tongue and groove	C60/75
	DLF10GSZ200x100	200	100	145	10	925	1 x 2,5 T	tongue and groove	C60/75
	DLF10GSZ225x100	225	100	165	10	1260	2 x 2,5 T	tongue and groove	C60/75
	DLF10GSZ250x100	250	100	165	10	1320	2 x 2,5 T	tongue and groove	C60/75
	DLF10GSZ275x100	275	100	165	10	1670	2 x 5 T	tongue and groove	C60/75
	DLF10GSZ300x100	300	100	200	10	1730	2 x 5 T	tongue and groove	C60/75
	DLF10GSZ325x100	325	100	225	10	2135	2 x 5 T	tongue and groove	C60/75
	DLF10GSZ350x100	350	100	225	10	2195	2 x 5 T	tongue and groove	C60/75
	DLF10GSZ375x100	375	100	250	10	2780	4 x 5 T	tongue and groove	C60/75
	DLF10GSZ400x100	400	100	250	10	2845	4 x 5 T	tongue and groove	C60/75
	DLF10GSZ425x100	425	100	285	10	3565	4 x 10 T	tongue and groove	C60/75
	DLF10GSZ450x100	450	100	285	10	3630	4 x 10 T	tongue and groove	C60/75
	DLF10GSZ500x100	500	100	325	13	5661	4 x 10 T*	tongue and groove	C60/75
DLF10GSZ550x100	550	100	325	10	5801	4 x 10 T*	tongue and groove	C60/75	
DLF10GSZ600x100	600	100	325	10	5924	4 x 10 T*	tongue and groove	C60/75	

LENGTH 2 M	DLF10GSZ150x200	150	200	115	10	1284	2 x 2,5 T	tongue and groove	C60/75
	DLF10GSZ175x200	175	200	145	10	1725	2 x 2,5 T	tongue and groove	C60/75
	DLF10GSZ200x200	200	200	145	10	1850	2 x 2,5 T	tongue and groove	C60/75
	DLF10GSZ225x200	225	200	165	10	2520	2 x 2,5 T	tongue and groove	C60/75
	DLF10GSZ250x200	250	200	165	10	2645	2 x 2,5 T	tongue and groove	C60/75
	DLF10GSZ275x200	275	200	165	10	3345	2 x 5 T	tongue and groove	C60/75
	DLF10GSZ300x200	300	200	200	10	3465	2 x 5 T	tongue and groove	C60/75
	DLF10GSZ325x200	325	200	225	10	4285	2 x 5 T	tongue and groove	C60/75
	DLF10GSZ350x200	350	200	225	10	4405	2 x 5 T	tongue and groove	C60/75
	DLF10GSZ375x200	375	200	250	10	5580	4 x 5 T	tongue and groove	C60/75
	DLF10GSZ400x200	400	200	250	10	5700	4 x 5 T	tongue and groove	C60/75
	DLF10GSZ425x200	425	200	285	10	7150	4 x 10 T	tongue and groove	C60/75
	DLF10GSZ450x200	450	200	285	10	7275	4 x 10 T	tongue and groove	C60/75
	DLF10GSZ500x200	500	200	325	13	11322	4 x 10 T*	tongue and groove	C60/75
DLF10GSZ550x200	550	200	325	10	11602	4 x 10 T*	tongue and groove	C60/75	
DLF10GSZ600x200	600	200	325	10	11848	4 x 10 T*	tongue and groove	C60/75	

4M	DLF10GSZ150x400	150	400	115	10	2570	2 x 2,5 T	tongue and groove	C60/75
----	-----------------	-----	-----	-----	----	------	-----------	-------------------	--------

- Constant wall thickness of 10 cm
- Wall thickness of 10 cm at top

* From the height 5m = KKA + RTA 10T

CAUTION, DLF10GSZ500x100 and the DLF10GSZ500x200 have a top thickness of **13 cm**.



DLF10GSRZ
uniform distributed
overload 25 kN/m²

DLF10GSRZ

WITH THESE WALLS, THE REAR SIDE IS UNDER LOAD.

The base must be back-filled to 1/3 of its height.

		HEIGHT CM	LENGTH CM	BASE CM	TOP THICK- NESS CM	WEIGHT KG	KKA	CONNECTION	CONCRETE QUALITY
LENGTH 1 M	DLF10GSRZ150x100	150	100	115	10	680	1 x 2,5 T	tongue and groove	C60/75
	DLF10GSRZ175x100	175	100	145	10	870	2 x 2,5 T	tongue and groove	C60/75
	DLF10GSRZ200x100	200	100	145	10	930	2 x 2,5 T	tongue and groove	C60/75
	DLF10GSRZ225x100	225	100	165	10	1270	2 x 2,5 T	tongue and groove	C60/75
	DLF10GSRZ250x100	250	100	165	10	1330	2 x 2,5 T	tongue and groove	C60/75
	DLF10GSRZ275x100	275	100	200	10	1680	2 x 5 T	tongue and groove	C60/75
	DLF10GSRZ300x100	300	100	200	10	1745	2 x 5 T	tongue and groove	C60/75
	DLF10GSRZ325x100	325	100	225	10	2155	2 x 5 T	tongue and groove	C60/75
	DLF10GRZS350x100	350	100	225	10	2215	2 x 5 T	tongue and groove	C60/75
	DLF10GSRZ375x100	375	100	250	10	2805	4 x 5 T	tongue and groove	C60/75
	DLF10GSRZ400x100	400	100	250	10	2865	4 x 5 T	tongue and groove	C60/75
	DLF10GSRZ425x100	425	100	285	10	3595	4 x 10 T	tongue and groove	C60/75
DLF10GSRZ450x100	450	100	285	10	3655	4 x 10 T	tongue and groove	C60/75	
LENGTH 2 M	DLF10GSRZ150x200	150	200	115	10	1360	2 x 2,5 T	tongue and groove	C60/75
	DLF10GSRZ175x200	175	200	145	10	1740	2 x 2,5 T	tongue and groove	C60/75
	DLF10GSRZ200x200	200	200	145	10	1865	2 x 2,5 T	tongue and groove	C60/75
	DLF10GSRZ225x200	225	200	165	10	2540	2 x 2,5 T	tongue and groove	C60/75
	DLF10GSRZ250x200	250	200	165	10	2665	2 x 2,5 T	tongue and groove	C60/75
	DLF10GSRZ275x200	275	200	200	10	3370	2 x 5 T	tongue and groove	C60/75
	DLF10GSRZ300x200	300	200	200	10	3495	2 x 5 T	tongue and groove	C60/75
	DLF10GSRZ325x200	325	200	225	10	4320	2 x 5 T	tongue and groove	C60/75
	DLF10GRZS350x200	350	200	225	10	4445	2 x 5 T	tongue and groove	C60/75
	DLF10GSRZ375x200	375	200	250	10	5625	4 x 5 T	tongue and groove	C60/75
	DLF10GSRZ400x200	400	200	250	10	5750	4 x 5 T	tongue and groove	C60/75
	DLF10GSRZ425x200	425	200	285	10	7210	4 x 10 T	tongue and groove	C60/75
DLF10GSRZ450x200	450	200	285	10	7335	4 x 10 T	tongue and groove	C60/75	
4M	DLF10GSRZ150x400	150	400	115	10	2720	2 x 2,5 T	tongue and groove	C60/75

- Constant wall thickness of 10 cm
- Wall thickness of 10 cm at top

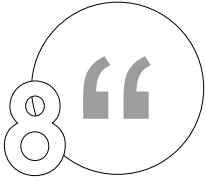

CUSTOMIZED L-WALLS

These are retaining walls or variable walls for demanding or standard loads that are delivered only on request and in consultation with our engineering department.

NEW

Formula 3

Variable VLF-walls for standard & heavy overload

Variable Wall thickness	12 cm, 15 cm, 20 cm
Lengths	Up to 400 cm
Heights	Up to 200 cm
Connection	Flat
Top finish	Bevelled edges at the top
Finish	Smooth
Concrete quality	C 60/75

Bevelled edges at the top

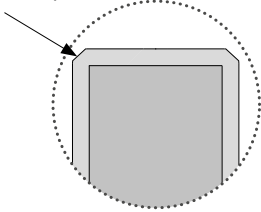

Without heel

CLVF12G

L-Walls, wall thickness 12 cm, without heel

- Wall thickness 12 cm
- Max length 400 cm
- Heights from 50 to 200 cm



DLVF15G

L-Walls, wall thickness 15 cm, without heel

- Wall thickness 15 cm
- Max length 400 cm
- Heights from 50 to 200 cm



DLVF20G

L-Walls, wall thickness 20 cm, without heel

- Wall thickness 20 cm
- Max length 400 cm
- Heights from 50 to 200 cm



With heel

CLVF12GZ

L-Walls, wall thickness 12 cm, with heel

- Wall thickness 12 cm
- Max length 400 cm
- Heights from 50 to 200 cm
- Heel max 50 cm



DLVF15GZ

L-Walls, wall thickness 15 cm, with heel

- Wall thickness 15 cm
- Max length 400 cm
- Heights from 50 to 200 cm
- Heel max 50 cm



DLVF20GZ

L-Walls, wall thickness 20 cm, with heel

- Wall thickness 20 cm
- Max length 400 cm
- Heights from 50 to 200 cm
- Heel max 50 cm



Without heel

		HEIGHT CM	LENGTH CM	BASE CM	TOP THICK- NESS CM	WEIGHT KG	KKA	CONNECTION	CONCRETE QUALITY	MAX. NUMBER OF PIECES PER PALETTE
LENGTH 2 M	CLVF12G 50x200	50	200	35	12	432	2 x 2,5 T	flat - flat	C60/75	0
	CLVF12G 100x200	100	200	60	12	876	2 x 2,5 T	flat - flat	C60/75	0
	CLVF12G 150x200	150	200	85	12	1319	2 x 2,5 T	flat - flat	C60/75	0
	CLVF12G 200x200	200	200	115	12	1793	2 x 2,5 T	flat - flat	C60/75	0
	DLVF15G 50x200	50	200	35	15	518	2 x 5 T	flat - flat	C60/75	0
	DLVF15G 100x200	100	200	60	15	1072	2 x 5 T	flat - flat	C60/75	0
	DLVF15G 150x200	150	200	85	15	1627	2 x 5 T	flat - flat	C60/75	0
	DLVF15G 200x200	200	200	115	15	2219	2 x 5 T	flat - flat	C60/75	0
	DLVF20G 50x200	50	200	35	20	641	2 x 5 T	flat - flat	C60/75	0
	DLVF20G 100x200	100	200	60	20	1380	2 x 5 T	flat - flat	C60/75	0
	DLVF20G 150x200	150	200	85	20	2120	2 x 5 T	flat - flat	C60/75	0
	DLVF20G 200x200	200	200	115	20	2909	2 x 5 T	flat - flat	C60/75	0

LENGTH 4 M	CLVF12G 50x400	50	400	35	12	864	2 x 2,5 T	flat - flat	C60/75	0
	CLVF12G 100x400	100	400	60	12	1752	2 x 2,5 T	flat - flat	C60/75	0
	CLVF12G 150x400	150	400	85	12	2638	2 x 2,5 T	flat - flat	C60/75	0
	CLVF12G 200x400	200	400	115	12	3586	2 x 2,5 T	flat - flat	C60/75	0
	DLVF15G 50x400	50	400	35	15	1036	2 x 5 T	flat - flat	C60/75	0
	DLVF15G 100x400	100	400	60	15	2144	2 x 5 T	flat - flat	C60/75	0
	DLVF15G 150x400	150	400	85	15	3254	2 x 5 T	flat - flat	C60/75	0
	DLVF15G 200x400	200	400	115	15	4438	2 x 5 T	flat - flat	C60/75	0
	DLVF20G 50x400	50	400	35	20	1282	2 x 5 T	flat - flat	C60/75	0
	DLVF20G 100x400	100	400	60	20	2760	2 x 5 T	flat - flat	C60/75	0
	DLVF20G 150x400	150	400	85	20	4240	2 x 5 T	flat - flat	C60/75	0
	DLVF20G 200x400	200	400	115	20	5818	2 x 5 T	flat - flat	C60/75	0



With heel

		HEIGHT CM	LENGTH CM	BASE CM	TOP THICK- NESS CM	WEIGHT KG	KKA	CONNECTION	CONCRETE QUALITY	MAX. NUMBER OF PIECES PER PALETTE
LENGTH 2 M	CLVF12GZ 50x200	50	200	65	12	610	2 x 2,5 T	flat - flat	C60/75	0
	CLVF12GZ 100x200	100	200	90	12	994	2 x 2,5 T	flat - flat	C60/75	0
	CLVF12GZ 150x200	150	200	115	12	1437	2 x 2,5 T	flat - flat	C60/75	0
	CLVF12GZ 200x200	200	200	145	12	2540	2 x 2,5 T	flat - flat	C60/75	0
	DLVF15GZ 50x200	50	200	65	15	741	2 x 5 T	flat - flat	C60/75	0
	DLVF15GZ 100x200	100	200	90	15	1297	2 x 5 T	flat - flat	C60/75	0
	DLVF15GZ 150x200	150	200	115	15	1853	2 x 5 T	flat - flat	C60/75	0
	DLVF15GZ 200x200	200	200	145	15	2795	2 x 5 T	flat - flat	C60/75	0
	DLVF20GZ 50x200	50	200	65	20	939	2 x 5 T	flat - flat	C60/75	0
	DLVF20GZ 100x200	100	200	90	20	1680	2 x 5 T	flat - flat	C60/75	0
DLVF20GZ 150x200	150	200	115	20	2421	2 x 5 T	flat - flat	C60/75	0	
DLVF20GZ 200x200	200	200	145	20	3211	2 x 5 T	flat - flat	C60/75	0	
LENGTH 4 M	CLVF12GZ 50x400	50	400	65	12	1220	2 x 2,5 T	flat - flat	C60/75	0
	CLVF12GZ 100x400	100	400	90	12	1988	2 x 2,5 T	flat - flat	C60/75	0
	CLVF12GZ 150x400	150	400	115	12	2824	2 x 2,5 T	flat - flat	C60/75	0
	CLVF12GZ 200x400	200	400	145	12	5080	2 x 2,5 T	flat - flat	C60/75	0
	DLVF15GZ 50x400	50	400	65	15	1482	2 x 5 T	flat - flat	C60/75	0
	DLVF15GZ 100x400	100	400	90	15	2594	2 x 5 T	flat - flat	C60/75	0
	DLVF15GZ 150x400	150	400	115	15	3706	2 x 5 T	flat - flat	C60/75	0
	DLVF15GZ 200x400	200	400	145	15	5590	2 x 5 T	flat - flat	C60/75	0
	DLVF20GZ 50x400	50	400	65	20	1878	2 x 5 T	flat - flat	C60/75	0
	DLVF20GZ 100x400	100	400	90	20	3360	2 x 5 T	flat - flat	C60/75	0
DLVF20GZ 150x400	150	400	115	20	4842	2 x 5 T	flat - flat	C60/75	0	
DLVF20GZ 200x400	200	400	145	20	6422	2 x 5 T	flat - flat	C60/75	0	



ELF-walls for more demanding applications

Wall thickness	15 cm, 20 cm, 25 cm, 30 cm
Lengths	Up to 1200 cm
Heights	Up to 700 cm
Connection	Flat
Top finish	Bevelled edges at the top
Finish	Sight side, Smooth
Concrete quality	C 60/75

Bevelled edges
at the top

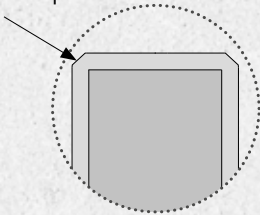

ELF-WALLS

HEAVY OVERLOAD

Specific conditions



ELF RANGE
heavy traffic according
to NBN EN 1991-2 edge
distance 0 m



ELF RANGE
heavy traffic according to
NBN EN 1991-2



ELF RANGE
heavy traffic according to NBN EN
1991-2





Corner elements

Up to and including a height of 3 m, it is possible to create an inner angle of 90° consisting of 1 piece. Above a height of 3.25 m, a 2-part 90° angle (2 x 45°) is used.

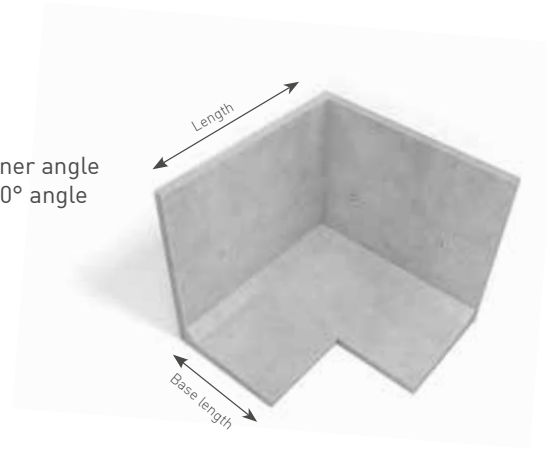

CLF10GSVH: FIXED 90° ANGLE

	HEIGHT CM	LENGTH CM	BASE CM	TOP THICK- NESS CM	WEIGHT KG	KKA	CONNECTION	CONCRETE QUALITY	MAX. NUMBER OF PIECES PER PALETTE	
CLF10GSVH	CLF10GSVH50x100	50	2 x 100	35	10,00	350	2 x 2,5 T	tongue and groove	C60/75	1
	CLF10GSVH50x200	50	2 x 200	35	10,00	735	4 x 2,5 T	tongue and groove	C60/75	0
	CLF10GSVH75x100	75	2 x 100	60	10,00	530	2 x 2,5 T	tongue and groove	C60/75	1
	CLF10GSVH75x200	75	2 x 200	60	10,00	1160	4 x 2,5 T	tongue and groove	C60/75	0
	CLF10GSVH100x100	100	2 x 100	60	10,00	645	2 x 2,5 T	tongue and groove	C60/75	1
	CLF10GSVH100x200	100	2 x 200	60	10,00	1395	4 x 2,5 T	tongue and groove	C60/75	0
	CLF10GSVH125x100	125	2 x 100	85	10,00	790	3 x 2,5 T	tongue and groove	C60/75	1
	CLF10GSVH125x200	125	2 x 200	85	10,00	1790	4 x 2,5 T	tongue and groove	C60/75	0
	CLF10GSVH150x100	150	2 x 100	85	10,00	905	3 x 2,5 T	tongue and groove	C60/75	1
	CLF10GSVH150x200	150	2 x 200	85	10,00	2025	4 x 2,5 T	tongue and groove	C60/75	0
	CLF10GSVH175x125	175	2 x 125	115	10,00	1545	4 x 2,5 T	tongue and groove	C60/75	0
	CLF10GSVH175x200	175	2 x 200	115	10,00	2710	4 x 2,5 T	tongue and groove	C60/75	0
	CLF10GSVH200x125	200	2 x 125	115	10,00	1690	4 x 2,5 T	tongue and groove	C60/75	0
	CLF10GSVH200x200	200	2 x 200	115	10,00	2945	4 x 2,5 T	tongue and groove	C60/75	0
	CLF10GSVH225x200	225	2 x 200	135	10,00	3965	4 x 2,5 T	tongue and groove	C60/75	0
	CLF10GSVH250x200	250	2 x 200	135	10,00	4200	4 x 2,5 T	tongue and groove	C60/75	0
CLF10GSVH275x200	275	2 x 200	160	10,00	5190	4 x 5 T*	tongue and groove	C60/75	0	
CLF10GSVH300x200	300	2 x 200	160	10,00	5430	4 x 5 T*	tongue and groove	C60/75	0	

- Constant wall thickness of 10 cm
- Wall thickness of 10 cm at top

* An additional lifting hook of type **HBS MRd24** is required for unloading and positioning the **CLF10GSVH 275** and **CLF10GSVH 300**.

FITTING POSSIBLE FIXED ANGLE UP TO 3 M HEIGHT

Length shortened

CAUTION!

The legs of an angle can be shortened on the left and/or right, but they cannot be shorter than the foot length.

Some examples:

- CLF10GSVH250x200 has legs with a minimum length of 135 cm, as the base is 135 cm long.
- CLF10GSVH50x200 has legs with a minimum length of 35 cm, as the base is 35 cm long.

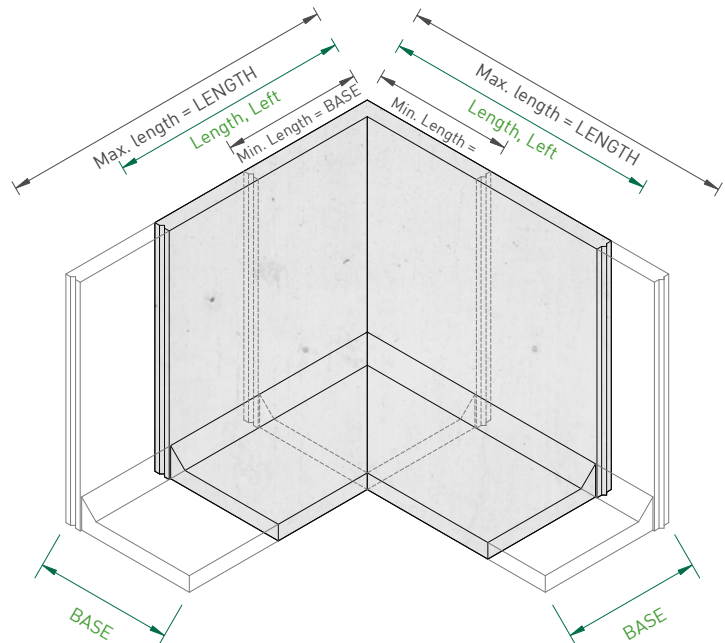

CLF10GSHL/HR: TWO-PART 90° ANGLE (2 X 45°)

		HEIGHT CM	LENGTH CM	BASE CM	KKA	WEIGHT KG
CLF10GSHL - HLL	CLF10GSHL300x200	300	200	159	2 x 5 T	2790
	CLF10GSHL325x200	325	200	185	2 x 5 T	3245
	CLF10GSHL350x200	350	200	185	2 x 5 T	3360
	CLF10GSHL375x200	375	200	200	3 x 5 T	4160
	CLF10GSHL400x200	400	200	200	3 x 5 T	4280
	CLF10GSHL425x200	425	200	200	3 x 10 T	5155
	CLF10GSHL450x200	450	200	200	3 x 10 T	5275
	CLF10GSHL500x200	500	200	199	3 x 10 T*	7810
	CLF10GSHLL500x200	500	200	260	4 x 10 T*	10288
	CLF10GSHL550x200	550	200	199	3 x 10 T*	8074
	CLF10GSHLL550x200	550	200	260	4 x 10 T*	10557
	CLF10GSHL600x200	600	200	199	3 x 10 T*	8315
	CLF10GSHLL600x200	600	200	260	4 x 10 T*	10804

		HEIGHT CM	LENGTH CM	BASE CM	KKA	WEIGHT KG
CLF10GSHR - HRR	CLF10GSHR300x200	300	200	159	2 x 5 T	2790
	CLF10GSHR 325x200	325	200	185	2 x 5 T	3245
	CLF10GSHR 350x200	350	200	185	2 x 5 T	3360
	CLF10GSHR 375x200	375	200	200	3 x 5 T	4160
	CLF10GSHR 400x200	400	200	200	3 x 5 T	4280
	CLF10GSHR 425x200	425	200	200	3 x 10 T	5155
	CLF10GSHR 450x200	450	200	200	3 x 10 T	5275
	CLF10GSHR500x200	500	200	199	3 x 10 T*	7810
	CLF10GSHRR500x200	500	200	260	4 x 10 T*	10288
	CLF10GSHR550x200	550	200	199	3 x 10 T*	8074
	CLF10GSHRR550x200	550	200	260	4 x 10 T*	10557
	CLF10GSHR600x200	600	200	199	3 x 10 T*	8315
	CLF10GSHRR600x200	600	200	260	4 x 10 T*	10804

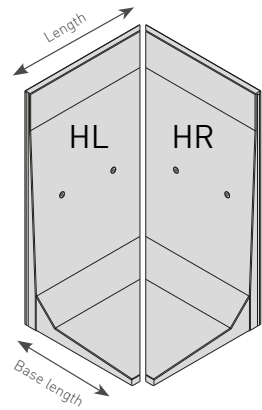

CLF10GSHL & CLF10GSHR

* From the height 5m = KKA + RTA 10T

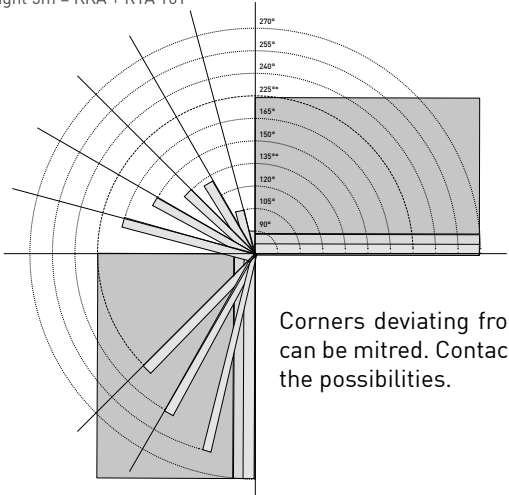
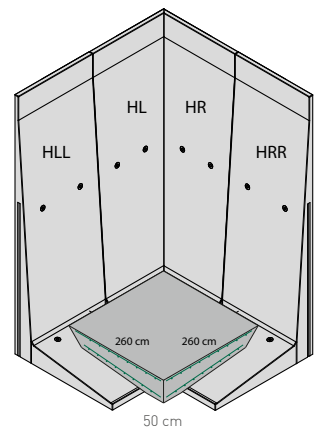
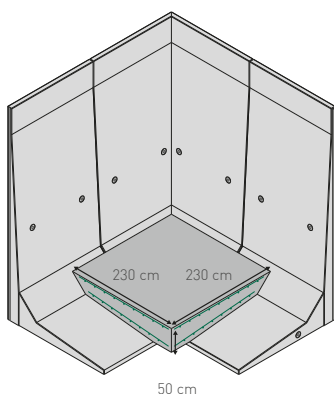

Corners deviating from 90° can be mitred. Contact us for the possibilities.

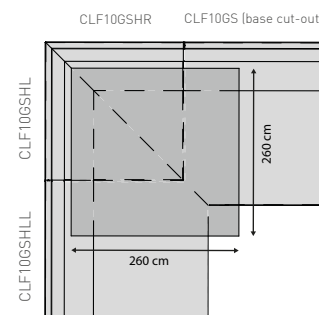
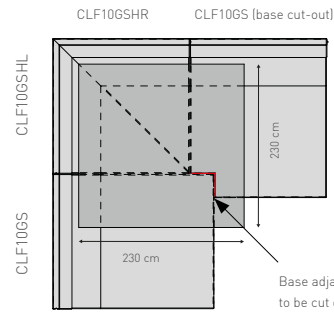

Reinforced concrete plate
 - C25/30
 - $c_{nom} = 5$ cm
 - Reinforcement (top and bottom):
 A393 (Ø 10-200-200)

From a height of 3.25 m, the stability of your retaining wall is ensured by installing a concrete-filled layer and should be braced..

CLF10GSRVH: FIXED 90° ANGLE FOR REVERSE PLACEMENT

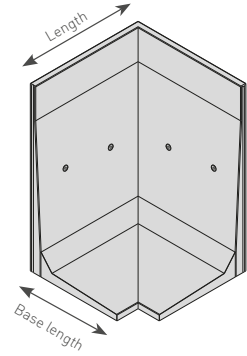

	HEIGHT CM	LENGTH CM	BASE CM	TOP THICKNESS CM	WEIGHT KG	KKA	CONNECTION	CONCRETE QUALITY	MAX. NUMBER OF PIECES PER PALLETTE	
CLF10GSRVH	CLF10GSRVH125x100	125	2 x 100	85	10,00	800	4 x 2,5 T	tongue and groove	C60/75	1
	CLF10GSRVH125x200	125	2 x 200	85	10,00	1810	4 x 2,5 T	tongue and groove	C60/75	0
	CLF10GSRVH150x100	150	2 x 100	85	10,00	920	4 x 2,5 T	tongue and groove	C60/75	1
	CLF10GSRVH150x200	150	2 x 200	85	10,00	2050	4 x 2,5 T	tongue and groove	C60/75	0
	CLF10GSRVH175x125	175	2 x 125	115	10,00	1560	4 x 2,5 T	tongue and groove	C60/75	0
	CLF10GSRVH175x200	175	2 x 200	115	10,00	2745	4 x 2,5 T	tongue and groove	C60/75	0
	CLF10GSRVH200x125	200	2 x 125	115	10,00	1710	4 x 2,5 T	tongue and groove	C60/75	0
	CLF10GSRVH200x200	200	2 x 200	115	10,00	2985	4 x 2,5 T	tongue and groove	C60/75	0
	CLF10GSRVH225x200	225	2 x 200	135	10,00	4015	4 x 2,5 T	tongue and groove	C60/75	0
	CLF10GSRVH250x200	250	2 x 200	135	10,00	4255	4 x 2,5 T	tongue and groove	C60/75	0
	CLF10GSRVH275x200	275	2 x 200	160	10,00	5255	4 x 5 T*	tongue and groove	C60/75	0
	CLF10GSRVH300x200	300	2 x 200	160	10,00	5495	4 x 5 T*	tongue and groove	C60/75	0

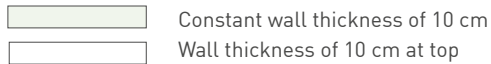

* An additional lifting hook of type **HBS MRd24** is required for unloading and positioning the **CLF10GSRVH 275** and **CLF10GSRVH 300**.

CLF10GSRHL/HR: TWO-PART 90° ANGLE (2 X 45°) FOR REVERSE PLACEMENT

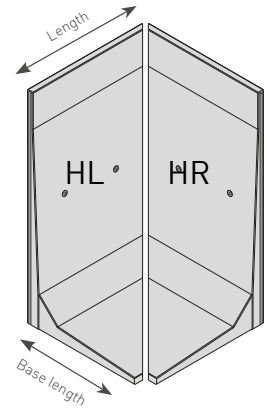

	HEIGHT CM	LENGTH CM	BASE CM	KKA	WEIGHT KG	
CLF10GSRHL	CLF10GSRHL325x200	325	200	185	2 x 5 T	3285
	CLF10GSRHL350x200	350	200	185	2 x 5 T	3405
	CLF10GSRHL375x200	375	200	200	2 x 5 T	4215
	CLF10GSRHL400x200	400	200	200	2 x 5 T	4335
	CLF10GSRHL425x200	425	200	200	2 x 10 T	5220
	CLF10GSRHL450x200	450	200	200	2 x 10 T	5340

	HEIGHT CM	LENGTH CM	BASE CM	KKA	WEIGHT KG	
CLF10GSRHR	CLF10GSRHR 325x200	325	200	185	2 x 5 T	3285
	CLF10GSRHR 350x200	350	200	185	2 x 5 T	3405
	CLF10GSRHR 375x200	375	200	200	2 x 5 T	4215
	CLF10GSRHR 400x200	400	200	200	2 x 5 T	4335
	CLF10GSRHR 425x200	425	200	200	2 x 10 T	5220
	CLF10GSRHR 450x200	450	200	200	2 x 10 T	5340

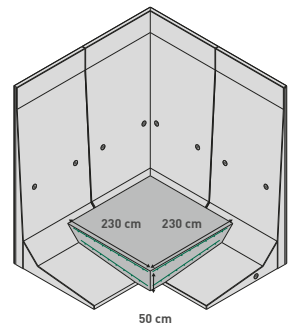

DLF10GSVH: FIXED 90° ANGLE SINGLE TURN FOR HEAVIER LOADS

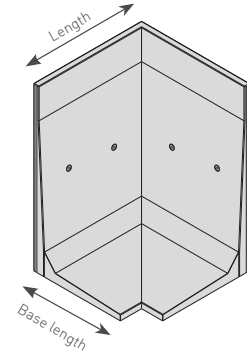

	HEIGHT CM	LENGTH CM	BASE CM	TOP THICKNESS CM	WEIGHT KG	KKA	CONNECTION	CONCRETE QUALITY	MAX. NUMBER OF PIECES PER PALLETTE	
DLF10GSVH	DLF10GSVH175x125	175	2 x 125	115	10,00	1560	4 x 2,5 T	tand-groef	C60/75	0
	DLF10GSVH175x200	175	2 x 200	115	10,00	2745	4 x 2,5 T	tand-groef	C60/75	0
	DLF10GSVH200x125	200	2 x 125	115	10,00	1710	4 x 2,5 T	tand-groef	C60/75	0
	DLF10GSVH200x200	200	2 x 200	115	10,00	2985	4 x 2,5 T	tand-groef	C60/75	0
	DLF10GSVH225x200	225	2 x 200	135	10,00	4015	4 x 2,5 T	tand-groef	C60/75	0
	DLF10GSVH250x200	250	2 x 200	135	10,00	4255	4 x 2,5 T	tand-groef	C60/75	0
	DLF10GSVH275x200	275	2 x 200	160	10,00	5255	4 x 5 T*	tand-groef	C60/75	0
	DLF10GSVH300x200	300	2 x 200	160	10,00	5495	4 x 5 T*	tand-groef	C60/75	0

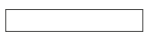
 Wall thickness of 10 cm at top

* An additional lifting hook of type **HBS Mrd24** is required for unloading and positioning the **CLF10GSVH 275** and **CLF10GSVH 300**.

DLF10GSHL/HR: TWO-PART 90° ANGLE (2 X 45°)

	HEIGHT CM	LENGTH CM	BASE CM	KKA	WEIGHT KG	
DLF10GSHL/HLL	DLF10GSHL325x200	325	200	185	2 x 5 T	3285
	DLF10GSHL350x200	350	200	185	2 x 5 T	3651
	DLF10GSHL375x200	375	200	200	3 x 5 T	4215
	DLF10GSHL400x200	400	200	200	3 x 5 T	4335
	DLF10GSHL425x200	425	200	200	3 x 10 T	5268
	DLF10GSHL450x200	450	200	200	3 x 10 T	5271
	DLF10GSZHL500x200	500	200	325	3 x 10 T	8977
	DLF10GSZHL550x200	550	200	325	3 x 10 T	9332
	DLF10GSZHL600x200	600	200	325	3 x 10 T	9626
	DLF10GSZHLL500x200	500	200	325	4 x 10 T	11482
	DLF10GSZHLL550x200	550	200	325	4 x 10 T	11877
	DLF10GSZHLL600x200	600	200	325	4 x 10 T	12179

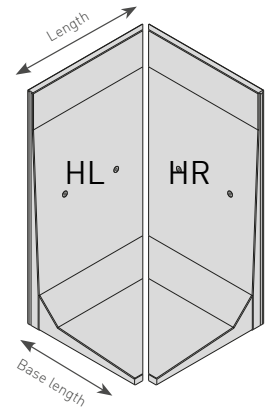

	HEIGHT CM	LENGTH CM	BASE CM	KKA	WEIGHT KG	
DLF10GSHR/HRR	DLF10GSHR 325x200	325	200	185	2 x 5 T	3285
	DLF10GSHR 350x200	350	200	185	2 x 5 T	3651
	DLF10GSHR 375x200	375	200	200	3 x 5 T	4215
	DLF10GSHR 400x200	400	200	200	3 x 5 T	4335
	DLF10GSHR 425x200	425	200	200	3 x 10 T	5268
	DLF10GSHR 450x200	450	200	200	3 x 10 T	5271
	DLF10GSZHR 500x200	500	200	325	3 x 10 T	8977
	DLF10GSZHR 550x200	550	200	325	3 x 10 T	9332
	DLF10GSZHR 600x200	600	200	325	3 x 10 T	9626
	DLF10GSZHRR500x200	500	200	325	4 x 10 T	11482
	DLF10GSZHRR550x200	550	200	325	4 x 10 T	11877
	DLF10GSZHRR600x200	600	200	325	4 x 10 T	12179

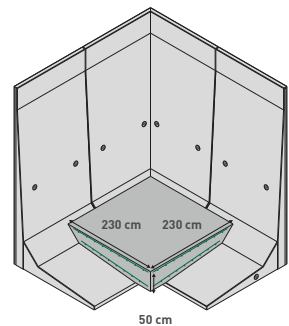

From a height of 5 metres, the 4-part corner element is always fitted with a heel (DLF10GSZHL/ZHR) for heavy overload.

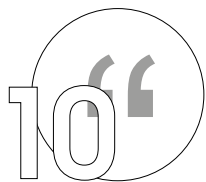

BORDER STONES

All sides smooth, perfect for combining with the CLF10GS retaining wall range. Only available in lengths of 1 m.

CLF10GB 30 X 100 CM

WEIGHT: 73KG

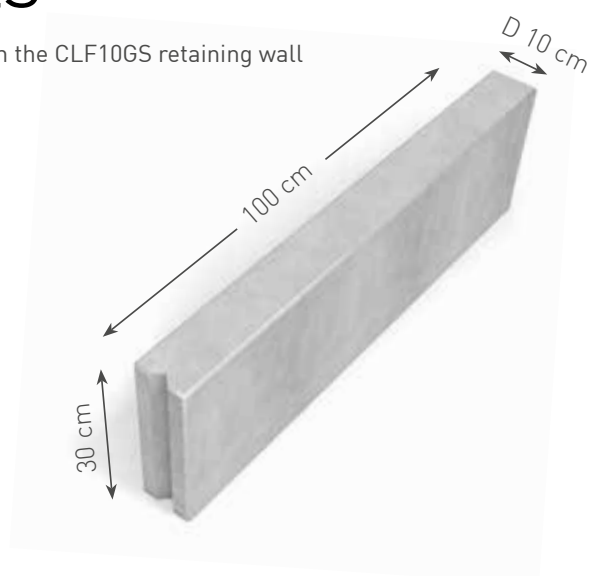

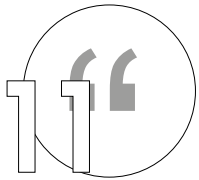

Convex and concave arcs

Placing retaining walls in an arc adds dynamism to a design. Radius retaining walls are always custom made and on request. There are 2 types of arcs: **convex and concave**. CBS Beton advises and assists the contractor, depending on the requirements and wishes of the client for new constructions or extensions.

LOADABLE FROM RADIUS (R)			
TYPE	CONCAVE - R(MIN) STANDARD	CONVEX - R(MIN) STANDARD	CONVEX - R(MIN) CUSTOM
CLF10GS50x100	6,8 m	12,7 m	6,8 m
CLF10GS75x100	6,8 m	25,2 m	6,8 m
CLF10GS100x100	6,8 m	25,2 m	6,8 m
CLF10GS125x100	6,8 m	37,7 m	6,8 m
CLF10GS150x100	6,8 m	37,7 m	6,8 m
CLF10GS175x100	6,8 m	51,4 m	8,9 m
CLF10GS200x100	6,8 m	51,4 m	8,9 m
CLF10GS225x100	6,8 m	59,7 m	11,9 m
CLF10GS250x100	6,8 m	59,7 m	11,9 m
CLF10GS275x100	6,8 m	70,3 m	15,2 m
CLF10GS300x100	6,8 m	70,3 m	15,2 m
CLF10GS325x100	6,8 m	82,8 m	15,2 m
CLF10GS350x100	6,8 m	82,8 m	15,2 m
CLF10GS375x100	6,8 m	93,8 m	20,6 m
CLF10GS400x100	6,8 m	93,8 m	20,6 m
CLF10GS425x100	6,8 m	103,8 m	22 m
CLF10GS450x100	6,8 m	103,8 m	22 m

Convex

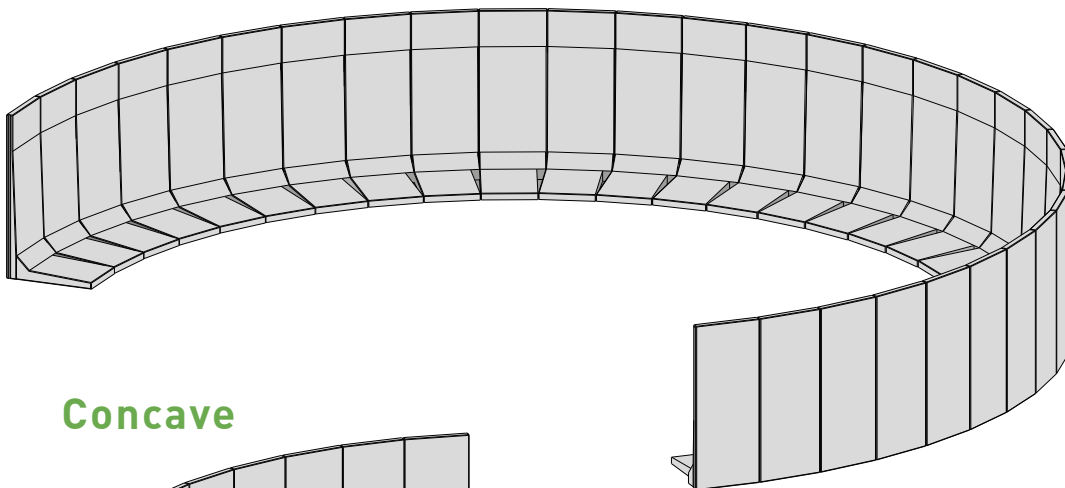

Concave

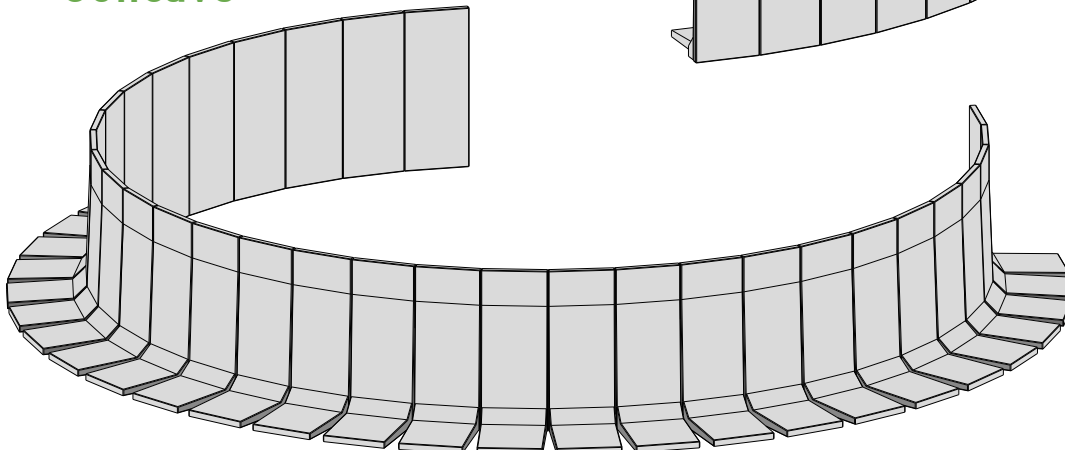

12

Parapet fastening

From a wall height of 125 cm*, a parapet can be attached to the walls.

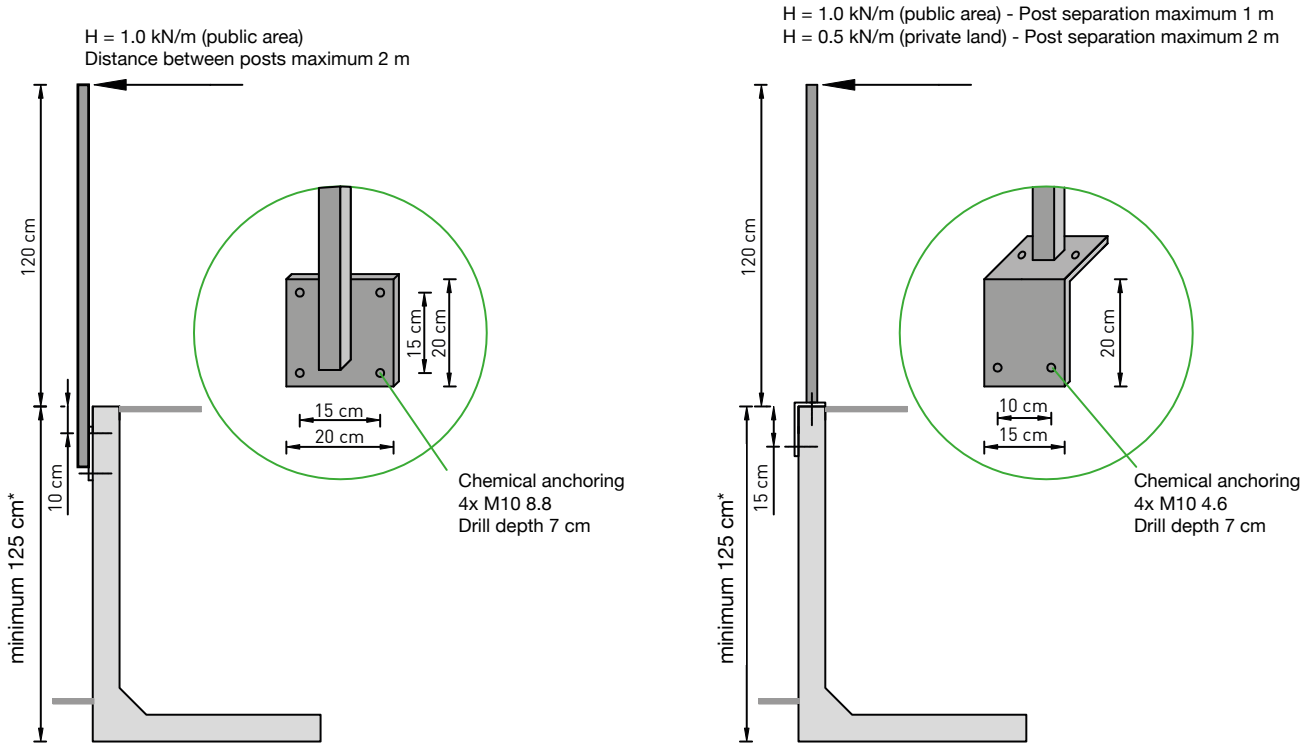

* for reverse use: min. 175 mm



13

Loading and packing

The following elements are delivered on euro pallets to facilitate loading and unloading.

CLF10GS	H	L	KG/ST	AANTAL STUKS / PALET	TOTAAL GEWICHT
CLF10GS50x100	50	100	195	4	780 kg
CLF10GS75x100	75	100	310	5	1550 kg
CLF10GS100x100	100	100	370	5	1850 kg
CLF10GS125x100	125	100	495	3	1485 kg
CLF10GS150x100	150	100	555	3	1665 kg
CLF10GS175x100	175	100	770	3	2310 kg
CLF10GS200x100	200	100	830	3	2490 kg
CLF10GS50x200	50	200	385	4	1540 kg
CLF10GS75x200	75	200	625	4	2500 kg
CLF10GS100x200	100	200	745	4	2980 kg
CLF10GS125x200	125	200	995	3	2985 kg
CLF10GS150x200	150	200	1115	3	3345 kg
CLF10GS50x400	50	400	770	4 x 2 pal	3080 kg
CLF10GS75x400	75	400	1250	4 x 2 pal	5000 kg
CLF10GS100x400	100	400	1490	4 x 2 pal	5960 kg
CLF10GS125x400	125	400	1990	2 x 2 pal	3980 kg
CLF10GSVH50x100x100	50	100	350	1	350 kg
CLF10GSVH75x100x100	75	100	530	1	530 kg
CLF10GSVH100x100x100	100	100	645	1	645 kg
CLF10GSVH125x100x100	125	100	790	1	790 kg
CLF10GSVH150x100x100	150	100	905	1	905 kg

Euro pallets are invoiced!

As much as possible, full pallets are loaded and filled according to the desired quantity.

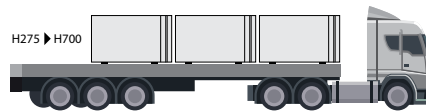
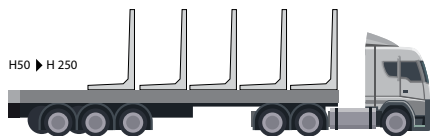

Elements from a height of 275 cm are loaded horizontally.

14

Lifting hooks

Lifting hooks of type **KKA 2.5 T - 5 T - 10** Tare required to move the walls. An additional lifting hook of type **HBS MRd24** is required for unloading and positioning the **CLF10GSVH 275** and **CLF10GSVH 300**.



KKA 10 T - KKA 5 T - KKA 2,5 T



HBS MRd24



CBS Beton NV

Hooimeersstraat 8, 8710 Wielsbeke, Belgium.

Tel.: 00 32 56 61 75 37 - info@cbs-beton.com - www.cbs-beton.com

We would like to point out that the information and notes in this technical catalogue do not constitute a complete and conclusive description. Rather, they are intended to supplement the generally recognised rules of building technology that the expert user must observe, and to explain the installation and use of our products. Further, we would like to point out that our products should only be used and installed by competent persons and that special attention should be paid to the proper handling and storage of our goods. We are always happy to assist you with the necessary advice and tips.